



**IndustrieAlpine Allee 1
D - 94513 Schönberg
Tel.:+49 (0) 85 54/9609-0
Fax:+49 (0) 85 54/96 09 20
Mail: sales@tetelectronics.de**

INSTRUCTION MANUAL

ARGOS-1200

High-performance power supplies

TABLE OF CONTENTS

1. Frontpanel layout description
2. Backpanel layout description
3. Installation
4. Constant voltage operation with current limiting
5. Constant current operation with voltage limiting
6. Sensing compensation
7. External programming
8. Overvoltage protection
9. Serial mode
10. Parallel mode
11. Tracking
12. Monitor and Status outputs
13. Over temperature protection
14. Appendix
15. References to special equipments

TECHNICAL SPECIFICATIONS

Model	Output Voltage	Output Current
Argos 30-40	0 - 30V	0 – 40A
Argos 40-30	0 - 40V	0 – 30A
Argos 60-20	0 - 60V	0 – 20A
Argos 100-12	0 - 100V	0 – 12A
Argos 160-7,5	0 - 160V	0 – 7,5A
Argos 200-6	0 - 200V	0 – 6,0A
Argos 250-4,8	0 - 250V	0 – 4,8A
Argos 300-4	0 - 300V	0 – 4,0A
Argos 350-3,4	0 - 350V	0 – 3,4A
Argos 500-2,4	0 - 500V	0 – 2,4A
Argos 1000-1,2	0 -1000V	0 – 1,2A
Argos 1200-1	0 -1200V	0 – 1,0A

Electrical Specifications

Constant voltage mode with adjustable current limiting

Output:

Ground isolated, floating up to 500 VDC (1000V)

Voltage adjustment range:

From $V_o \leq 0,1 V$ up to V rated with a 10-Turn Potentiometer

Regulation accuracy:

LINE: 0.01% by +/- 10% line fluctuation

LOAD: 0.025% no load to full load measured at sensing terminals

Recovery time:

10ms for a load change from 5% to 100% and regulation within 100mV

10ms for a load change from 100% to 5% and regulation within 100mV

5ms for a load change of 30% and regulation within 50mV

Ripple:

$\leq 30mV_{rms}$, 120 mVss

Temperature coefficient:

0.01%/K measured within a 0... + 50°C range

Short circuit protection:

Automatic current limiting adjustable from $\square 100mA$ to rated current

Compensation:

1 V or 1% maximum drop per load line 1)

Constant current mode with adjustable voltage limiting

Current adjustment range:

Continuously from $\square 100mA$ up to rated current adjustable with a 10 -turn potentiometer

Regulation accuracy:

LINE: 0.01% by +/-10% line fluctuation

LOAD: 0.1% from full load to short circuit

Temperature coefficient:

0.01%/K measured in a range of 0... +50°C

Physical-Specifications

Dimensions:

H x W x D (without function elements , however with rearpanel connectors): 88x443x390 mm

Weight: appr. 14,5 kg

General Specifications

Design principle: switching mode

External programming:

Remote ON/OFF control input

0-10V programming input for V = 0-100%

0-10V programming input for C = 0-100%

0-12V programming input for OV = 0-120%

2 monitor outputs: 0-10V for V and C = 0-100%

IEEE-488 / RS 232 listener/talker interface (optional)

Operation modes :

Voltage regulation with adjustable current limiting, current regulation with adjustable voltage limiting. (The switching over

from one mode to the other is done automatically)

Displays:

Analog meters for voltage and current Cl . 2.5

Storage temperature: -20...+70°C

Operating temperature: 0... +50°C without derating

Cooling:

Forced cooling, internal fan, suction area in the front, blowing through rearpanel.

Line-voltage input:

230V AC +/-10% 47...65Hz

Current-consumption:

Approx. 7,0A by 230V inrush current limited on rated current

Options:

Opt.04: Power-factor-control

Opt.07: 115V_{AC} Input voltage

Opt.34: IEEE-488/RS232 listener/talker interface

Opt.50: Digital display (LED)

Opt.99: 19" rack mounting kit

Accessories

Manual

Main-power cable with plugs

1) Wichever greater

1. Frontpanel layout description

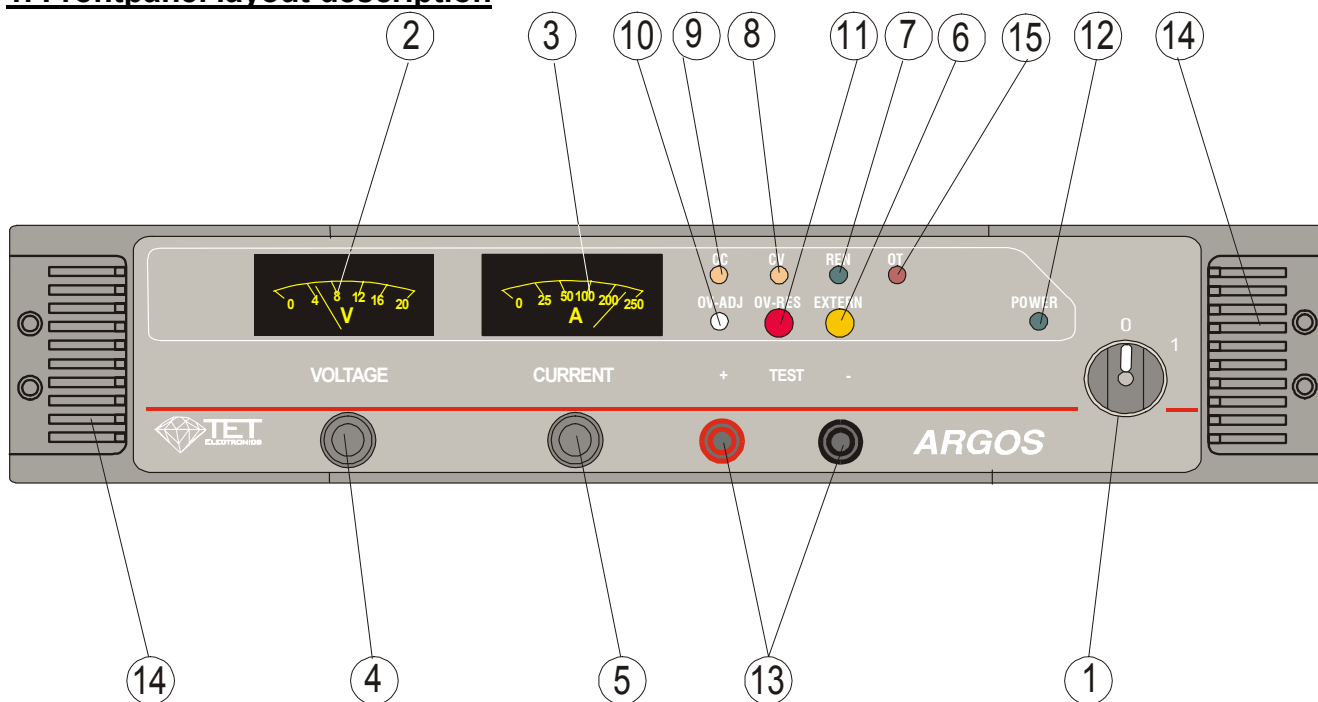

Fig. 1

- 1 Power switch
- 2 Voltage output display
- 3 Current output display
- 4 Voltage adjustment control (10 turn pot)
- 5 Current adjustment control (10 turn pot)
- 6 External/internal switch and External LED indicator
- 7 Remote enable indicator
- 8 LED indicator for constant voltage mode
- 9 LED indicator for constant current mode
- 10 Adjustment control for the OV-protection
- 11 Overvoltage reset button and overvoltage LED indicator
- 12 Power ON indicator
- 13 Test sockets for output voltage
- 14 Ventilation slits
- 15 Overtemperature (OT) indicator

CAUTION The test sockets (13) are not appropriate to draw current

2. Backpanel layout description (see Fig.2)

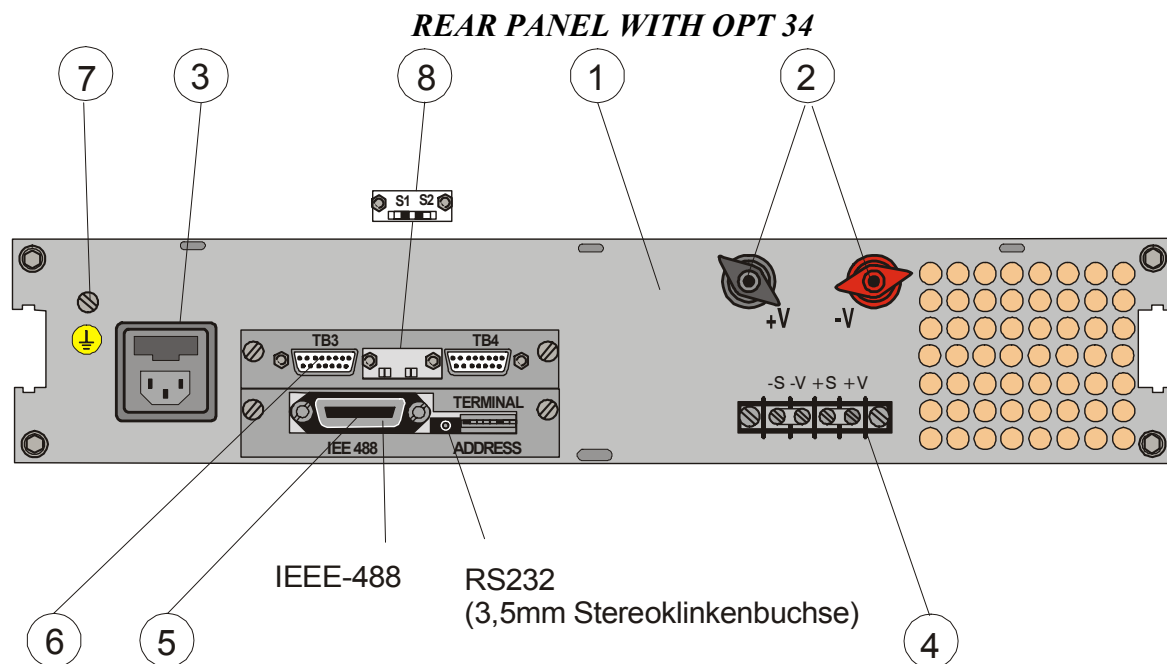
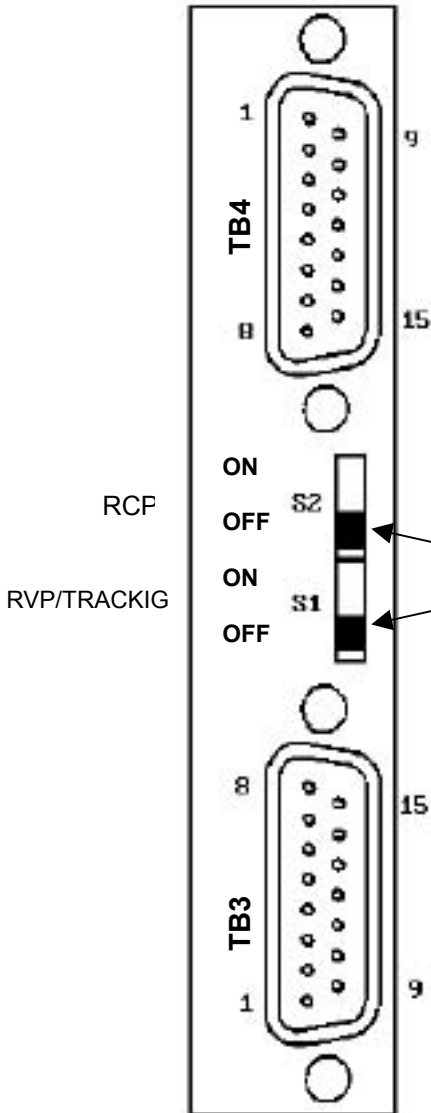

Fig. 2

- 1 Power supply rearpanel
- 2 +/- Load terminals
- 3 AC input and main fuse (TB1)
- 4 Terminal block for +/- sense line and output voltage +V, -V (TB2)
- 5 Opt 34, IEEE bus interface connector, address switches and RS-232 connector
- 6 Regulation board with TB3, TB4, S1 and S2
- 7 Grounding screw
- 8 Blind frame for switch S1/S2

TB 4 pin layout
15 Pin Sub-D connector



TB 4 - 1	CC STATUS
TB 4 - 2	OV STATUS LATCHED
TB 4 - 3	(-) 15V
TB 4 - 4	(+) 15V
TB 4 - 5	OV PROG
TB 4 - 6	I PROG
TB 4 - 7	U-MONITOR
TB 4 - 8	GND
TB 4 - 9	OV RESET DIG
TB 4 - 10	REM ON/OFF DIG
TB 4 - 11	GND
TB 4 - 12	OTP-STATUS
TB 4 - 13	I-MONITOR
TB 4 - 14	GND
TB 4 - 15.....	U PROG

Setting and Function see chapter 7.2 and 7.4

TB 3 PIN LAYOUT
15 Pin Sub-D connector

TB 3 - 1.....	(+) SLAVE
TB 3 - 2.....	(+) MASTER
TB 3 - 3.....	(+) RCP
TB 3 - 4.....	(+) 10V REF
TB 3 - 5.....	(-) TRACKING
TB 3 - 6.....	REM ON/OFF
TB 3 - 7.....	OV RESET
TB 3 - 8.....	(+) RVP
TB 3 - 9.....	(-) SLAVE
TB 3 - 10	(-) MASTER
TB 3 - 11	(-) RCP
TB 3 - 12	GND or U-PROG *
TB 3 - 13	GND
TB 3 - 14	GND
TB 3 - 15	(-) RVP

Fig 3

* After june 1993 (Layout 4200-P1005): U-PROG

* Before june 1993 (Layout 4200-P0005): GND

3. Installation

Before using the power supply ARGOS a power cord has to be plugged in to the AC input (TB1) of the rear panel of the power supply. The power cord should at least support 7A load.

The ARGOS supply is immediately operational after powering up and a soft start time of approx. 3sec. The warmup time, at room temperature, in order to reach the high stability specifications is negligible.

Note: The outputs of the power source should not be connected to AC-sources, DC-sources with reverse polarity or DC-sources with higher voltage than $1.2 \times U_{\text{nominal}}$. If such an operating mode is inevitable (e.g. charging batteries, paralleling power sources or working with heavy inductive loads), the customer must assure proper safety measures.

4. Constant voltage mode with current limiting

This mode of operation is reached when the LED indicator "CV" illuminates. Because of the high stability of ARGOS it is possible to adjust accurately the output voltage to several decades. For this an adequate digital voltmeter should be used. The local adjustment is performed using the voltage control knob "VOLTAGE".

The adjustment to the desired and limited current is achieved by short-circuiting the output and using the current limiting control knob while reading the display.

5. Constant current mode with voltage limiting

This mode of operation is reached when the LED indicator "CC" illuminates. The height of the constant current is locally adjusted using the current control knob "CURRENT". The lower limit for the constant current operation is $\leq 100\text{mA}$.

It is important to be careful, particularly when working with small output currents, since the charging or discharging currents of the output capacitor affects the constant current depending on the charging condition of the output capacitor under dynamic loading condition.

The output voltage to be maximum limited is adjusted by using the voltage control knob and reading the display.

6. Remote sensing

Unavoidable voltage drops across the output terminals and the load lines can be compensated by including sensing leads in conjunction with the load. However it is important to make sure not to exceed a voltage drop of 1V or 1% from rated Voltage 1) per load line.

Circuit configuration

1. Jumpers between +V and +S and between -V and -S (terminal TB2 on the rear panel) are opened
2. The load leads (+V,-V) are linked to the output terminals of the supply and the sensing leads to the sensing terminals and then connected accordingly to the load.

NOTE

The +V, -V terminals at TB2 are not appropriate as power source !

When using the ARGOS power supply with interrupted sensing leads, the specified data can no longer be fulfilled. However the power supplies are internally protected so that no damage will result even with opened S-leads.

When using long sensing leads it is recommended to use shielded cables.

When proceeding with interrupted sensing leads the display will show approx. 2V or 2% from rated Voltage 1) less than the actual output voltage. The current display gives always the true value.

1) whichever greater

7. External programming

The output voltage, current and OV protection can be adjusted externally with programming voltages. The voltage and current can also be adjusted by means of resistance programming.

7.1 External voltage programming

The programming voltage source is connected with its minus lead to TB4-8 and its plus lead to TB4-15. To activate the external mode the switch "EXTERN" is pushed. The yellow LED indicator illuminates if the external mode is active.

The programming voltage may have values between 0 and + 10V. The output voltage is linear and proportional to the programming voltage.

The load for the auxiliary source is 150µA.

NOTE

1. When the programming line is interrupted during operation, the output voltage drops to zero.
2. When using long programming leads it is recommended to use shielded cable in order to prevent external distortions. It is also recommended to apply accordingly blocking capacitors to the terminals in case of oscillation due to the inductivity of long programming leads.
3. Ripple, stability and Tc of ARGOS depends on the auxiliary source specifications.

7.2 RVP (Resistance Voltage Programming)

The output voltage can be externally programmed using a 0 to 10 kOhm resistance. The configuration is shown here under.

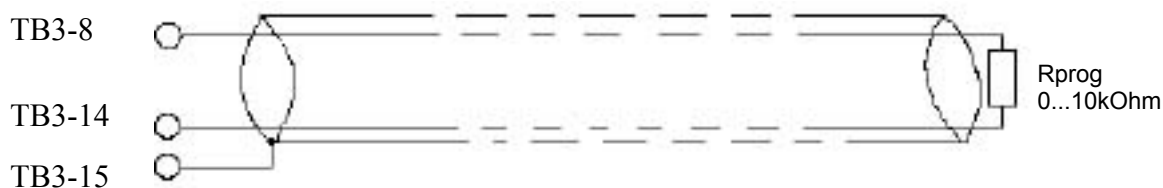

The output of the power supply is :

$$V_{out} = (R_{prog}/10) \times V_{max} \quad R_{prog} \text{ in kOhm; } V_{out}, V_{max} \text{ in volt}$$

NOTE:

- a) In order to prevent stability fault it is recommended to use oversized resistors (eg. 2W) with a Tc of $\leq 20 \text{ppm}/^\circ\text{C}$.
- b) During RVP mode the sliding switch S1 on the rear panel must be positioned on the right side and the "EXTERN" switch on the frontpanel in the position INTERN (not pushed).
- c) With $R_{prog} = 12 \text{kOhm}$ will $V_{out} = 1.2 \times V_{max}$
- d) In case $R_{prog} > 20 \text{kOhm}$ (interruption), the output voltage is programmed to zero.
- e) RVP and Tracking modes are effective simultaneously. The output voltage always results from the highest programmed value. If no voltage is on TB3-5 (TRACKING) the RVP mode is not influenced by the tracking mode (see Tracking mode).
- f) When the sliding switch S1 is in the left position the output voltage is adjusted with the control on the frontpanel. In this case Rprog has to be removed.

7.3 External current programming

The auxiliary programming voltage is connected as following :
minus to TB 4-14, plus to TB 4-6. When the EXTERNAL switch is pushed and the EXTERNAL mode active, the yellow LED indicator illuminates.
The programming voltage may have values between 0 and + 10V.
The output current results in a linear and proportional manner from the programming voltage.
Load for the auxiliary source is 150µA.

NOTE

1. When the programming line is interrupted during operation, the output current drops to zero.
2. When using long programming leads it is recommended to use shielded cable in order to prevent external distortions. It is also recommended to apply accordingly blocking capacitors to the terminals in case of oscillation due to the inductivity of long programming leads.
3. Ripple, stability and Tc of ARGOS depends on the auxiliary source specifications.

7.4 RCP (Resistance Current Programming)

The output current can be programmed externally by means of a 0 to 20 KOhm resistance. The configuration is as following:

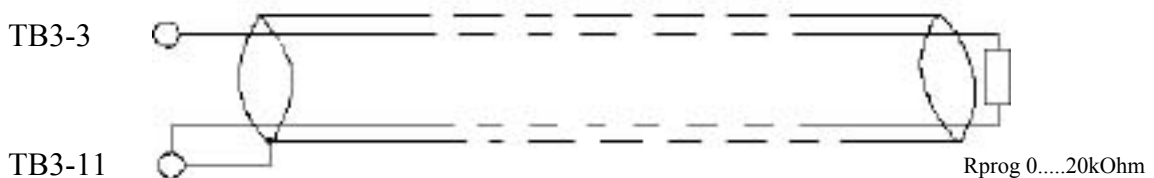

Shield

The output current is :

$$I_{out} = (R_{prog}/20) \times I_{max}$$

I_{out} , I_{max} , in Ampere R_{prog} in kOhm

NOTE

- a) In order to prevent stability fault it is recommended to use oversized resistors (eg. 2W) with a Tc of $\leq 20\text{ppm}/^\circ\text{C}$.
- b) During RCP mode the sliding switch S2 on the rear panel must be positioned on the right side and the "EXTERN" switch on the frontpanel in the position "INTERN" (not pushed).
- c) When $R_{prog} \geq 20\text{KOhm}$ (interruption), the output current will only be limited to about $1.2 \times I_{max}$ by the primary current limiting of the inverter. In this case however the CC LED on the frontpanel will not illuminate.

7.5 External OV-programming

NOTE

The regulation board is delivered with a short circuit jumper BR301, located close to the relay. In this way it is also possible in "EXTERNAL" mode to adjust OV internally. For external OV programming the jumper BR301 must be removed.

The auxiliary programming voltage is connected as following :
minus pole to TB 4-14, plus pole to TB 4-5. When the EXTERNAL switch is pushed and the EXTERNAL mode active, the yellow LED indicator illuminates.

The programming voltage may have values between 0 and + 12V.

The OV threshold results in a linear and proportional manner from the programming voltage (0....120%). Load for the auxiliary source is 250µA.

7.6

If only one output parameter is to be programmed, it is possible to adjust the non-programmed parameter to the maximum value. In order to achieve this, the non-programmed input (TB4-15 or TB4-6) is connected with the 10V REF output (TB3-4). The 10V REF auxiliary voltage may be loaded to max 15mA and is shortcircuit proof.

7.7 Remote ON/OFF

The power supply can be switched on and off using a relay contact or a logic signal. Contact will be established between TB 3-6 and TB 3-14 and loaded with 5mA.

The logic signal is high-active and should have a high level between 3.5 and 15 V and a low level under 0.8V. Load of the auxiliary signal is about 10KOhm. The connection of the logic signal is between TB4-14 (GND) and TB4-10 (active).

NOTE:

The power switch must be ON

8. Overvoltage protection

ARGOS power supplies are factory equipped with an adjustable threshold overvoltage protection. The threshold maximum value is 120% of the maximum adjustable output voltage (e.g. 48V for ARGOS 40-25).

Minimum spacing of threshold to output voltage approx. 0.5V.

8.1 Threshold adjustment:

1. OV control (described as OV adjust on frontpanel) is to be turned clockwise with a screw-driver until it stops (highest Threshold)
2. Power-up device and adjust output voltage to the desired value of threshold.
3. Turn back the OV control until the LED indicator in the OV-RES button illuminates.
4. Turn back somewhat the adjustment of OV, power device down, then one more time power up and by slowly turning up the voltage check the value of threshold.

Important

Should the threshold be over the maximum adjustable output voltage of device, a short-circuit proof auxiliary voltage (corresponding to the desired threshold) is to be applied on the load terminal.

8.2 OV RESET:

After an activation of the overvoltage circuit, it remains triggered until a RESET signal occurs. The OV RESET signal can be generated using a relay contact or a logic signal. Contact will be established between TB 3-7 and TB 3-14. The logic signal is high-active and should have a high level between 3.5 and 15 V and a low level under 0.8V. Load of the auxiliary signal is about 10KOhm. The connection of the logic signal is between TB4-11 (GND) and TB4-9 (active). In case the contact is always closed or the logic signal permanently high, the overvoltage protection circuit will be ineffective.

CAUTION:

A built-in OV-thyristor (optional), should not be exposed to a permanent current. When an active load is connected (e.g. accumulator) a redundant diode is to be used between device and load. In this case the sensing compensation is only possible if the total voltage drop on the sensing lead and the redundant diode is <2V (2%).

9. Series operation

Series operation of ARGOS power supplies enable a higher output voltage, however the total output voltage should not exceed 300V. Besides it is to be noted that a voltage drop due to the connecting lines is generated according to the current load. For an accurate regulation the following configuration is to be respected.

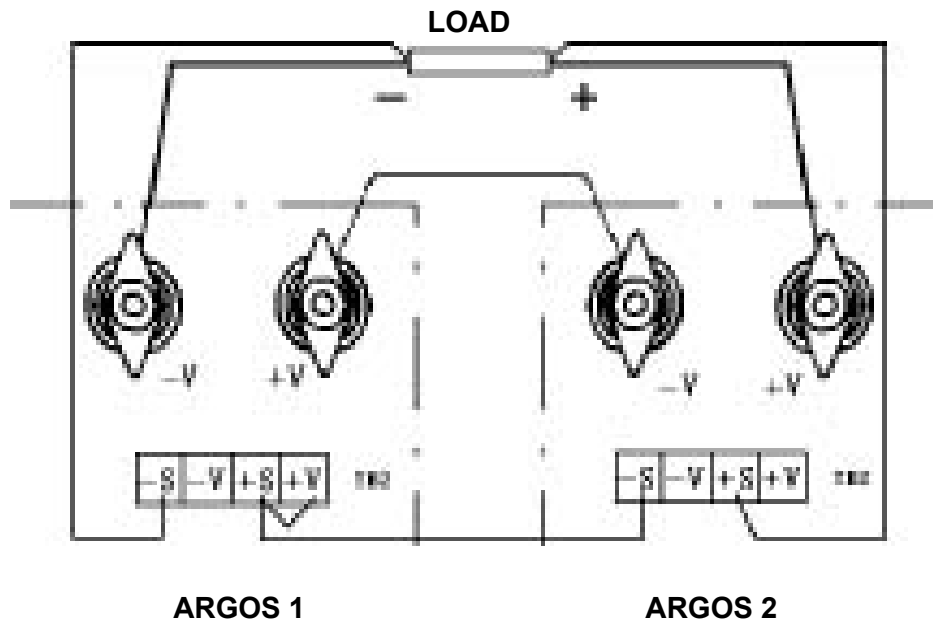

Fig. 6

9.1 Remove Jumpers:

- 1.1 For ARGOS 1, Jumper between -S and -V
- 1.2 For ARGOS 2, jumpers between -S and -V, also between +S and +V

9.2 Connections

- 2.1 ARGOS 2 +V load terminal to the plus pole of load (wire with sufficient cross section $\geq 5A/mm^2$)
- 2.2 ARGOS 1 -V load terminal to minus pole of load (cross section $\geq 5A/mm^2$)
- 2.3 ARGOS 2 -V load terminal to ARGOS 1 +V load terminal (cross section $\geq 5A/mm^2$)
- 2.4 ARGOS 2 +S to plus pole of load
- 2.5 ARGOS 2 -S to ARGOS 1 +S
- 2.6 ARGOS 1-S to minus pole of load

The output voltages are adjusted via the corresponding "VOLTAGE" Pots.. The total output voltage is the sum of the two adjusted voltages. When the current limit values are not equal, the **higher** value applies as valid total current limit. When one ARGOS surpasses its current limit it will deliver no energy anymore and will have a small negative voltage ($< 1V$) at its load terminal.

Because none of the two ARGOS measures the total voltage, an overvoltage protection function (OVP) is not possible. In order to obtain an even load distribution it is recommended to adjust the "VOLTAGE" and "CURRENT" control of both ARGOS in such a way that they display an equal voltage. Devices should be switched on and off simultaneously.

10. Parallel operation

If higher output currents are required it is possible to have the ARGOS power supplies operate in a parallel manner.

10.1 Simple output load terminals connection

Please note the following :

In order to get an even load current distribution, both ARGOS power supplies have to be adjusted to the same output voltage prior to connecting the output load terminals. The connecting cables should be as short as possible and with corresponding cross section. Because it is not possible to ensure a simultaneously switch off of the devices in case of an over voltage, decoupling diodes should be used. In that case a sensing compensation is not possible (see also point 8).

If an accurate regulation is necessary an Auto-Load-Share Parrelling operation is to be configured (point 10.2).

10.2 Auto-Load-Share Parrelling Operation

(only possible with supplies of same voltage and current range)

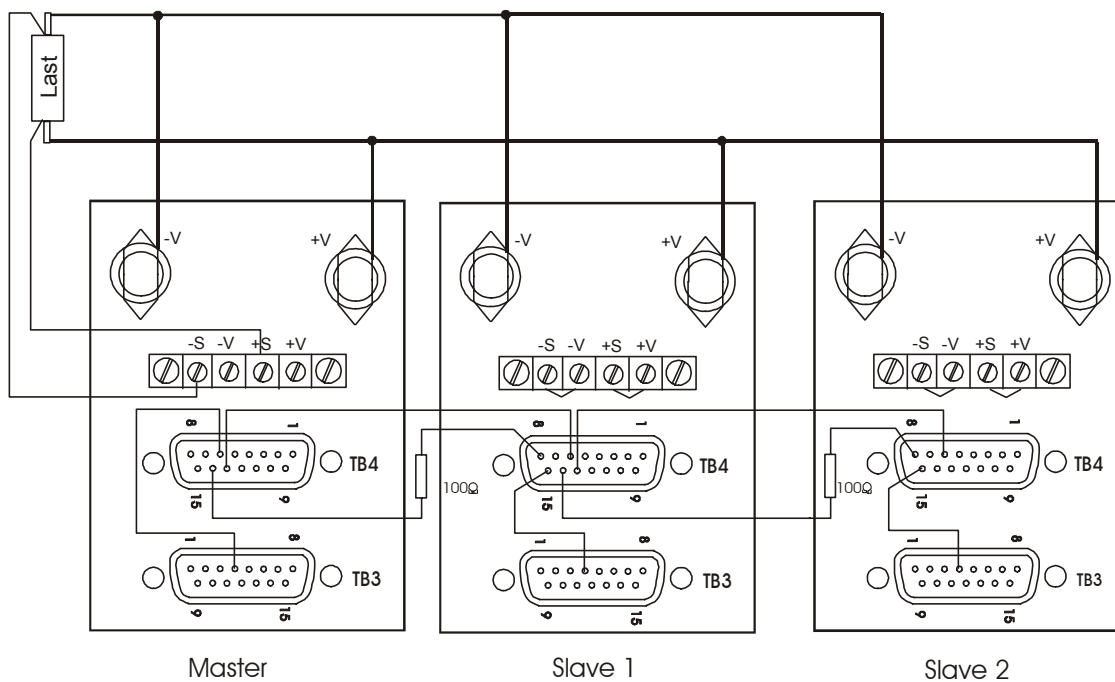

Fig. 7

Configuration (see Fig. 7)

Select any one of the ARGOS power supplies as a master, the others (max. 3) as slave(s).

1. Remove Jumpers:

For master ARGOS Jumpers between +S and +V, also -S and -V

2. Connections

- 2.1 All ARGOS +V load terminals to the plus pole of load (with sufficient wire cross section $\geq 5A/1mm^2$)
- 2.2 All ARGOS -V load terminals to minus pole of load (cross section $\geq 5A/1mm^2$)
- 2.3 Master -S to minus pole of load
- 2.4 Master +S to plus pole of load
- 2.5 (TB 3 - 4) master to (TB 4 - 6) master
- 2.6 (TB 4 - 13) master to (TB 4 - 6) first slave
- 2.7 (TB 1 - 14) master with an 100 Ω Resistor to (TB 4 - 8) first slave
- 2.8 The first slave ARGOS is used as master for the second slave device and so on
- 2.9 (TB 4-15) of first slave to (TB 3-4) of first slave. This one do for all slaves again.

3. Please note

- 3.1 All ARGOS power supplies have to be switched on and off simultaneously
- 3.2 In view of the stability no more than 3 slave ARGOS should be configured.

4. Operation

- 4.1 "VOLTAGE", "CURRENT" and "OV ADJUST" controls of all slaves are turned clockwise to the maximum.
- 4.2 By all the slaves push the EXTERN-knob
- 4.3 The desired overvoltage limit should be adjusted on the master (see chap. 8)
- 4.4 Voltage and current limiting adjustments are performed using the master controls. The total current limit in that case is $I_{lim\ total} = (n+1) I_{lim}$, n is the number of slaves and I_{lim} the adjusted current limit of the master.

11. Tracking mode

The tracking mode permits to structure a symmetric power supply. For this two ARGOS are necessary, the unit with negative output acts as master.

Configuration:

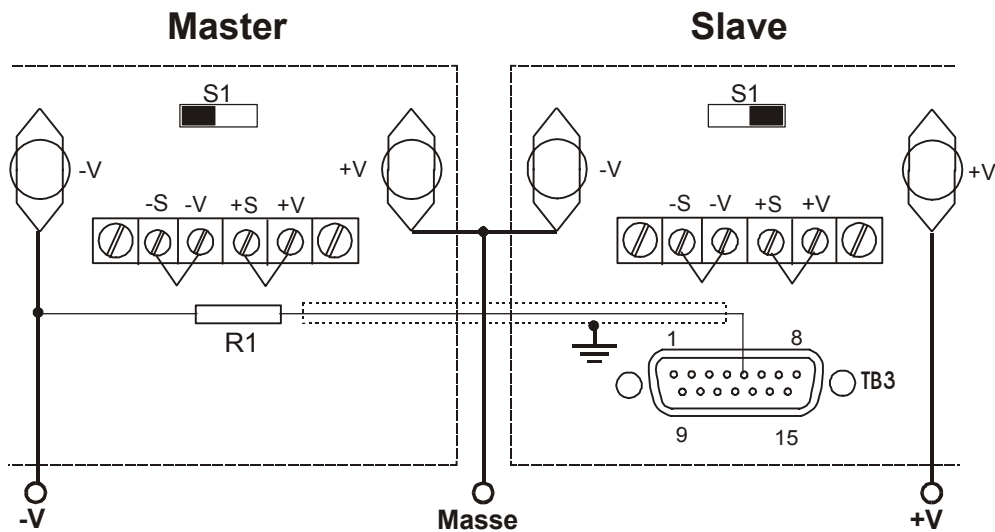

Fig. 8

The resistance R1 is calculated using the following formula:

$$R1 = (V_{\max} / 5 - 1) \times 20 \text{ k}\Omega$$

V_{\max} is the maximum output voltage in Volt of the master device.

The resistor R1 should be oversized (eg. 2W) with a Tc of $\leq 20 \text{ ppm}/^\circ\text{C}$.

NOTE:

a) In tracking mode the slave ARGOS is to be set in RVP mode. (S1 right, EXTERN not pushed). However a programming resistor is not connected, consequently RVP programming is set to zero. Because the output voltage results from the highest programmed value, the tracking mode affects the total output voltage range.

b) The slave output voltage always results from the one of the master, independently of the operation mode of the later, except if the current limiting or the OV protection of the slave ARGOS is activated.

12. Monitor and status outputs

12.1 Monitor outputs

The output voltage and current can be read via two analog signals. Those signals are proportional with the output parameters and are rated to + 10V. They are marked "V-Monitor" (TB 4-7) and "I-Monitor" (TB 4-13) and measured against TB 4-14.

Both monitor outputs may be loaded with max. 10mA.

12.2 Status signals

Both status outputs are "open-collector" outputs, related to TB 4-8 and may be loaded with max. 100mA. Outputs are "low" active. If device works in constant current mode, the CC status output (TB 4-1) is always active. The OV status output (TB 4-2) is active if the OV protection circuit has turned off the power supply and remains active until the OV button is pushed or a OV-RESET signal is applied.

ARGOS is equipped with a 2 step temperature control circuit. Whenever the temperature of the Power-Mosfet's approx. surpasses 65°C, the fan is switched to a faster speed. If the Mosfet-temperature surpasses approx. 100°C an acoustic signal is generated and the OT LED indicator illuminates (red). Simultaneously the output power is slowly diminished. During this state only the MOSFET's temperature (approx. 85°C) is regulated. The LED indicators CV and CC do not light up as ARGOS under such conditions can not full fill the specifications.

This status is not latched and after the Mosfet's are cooled the ARGOS goes back in a normal operation mode (CC or CV).

14. APPENDIX

Please note followings :

IEEE-488 / RS 232 INTERFACE (OPT 34) Starting with Series Nr.: 907785 an automatic switching from " INTERN " to " EXTERN " is implemented. If the BUS activates the IEEE-Interface, the powersupply switches automatically in " Extern / Remote " mode. The command "LOCAL" switches then automatically back to " INTERN " mode. For the RS 232 Interface the command " B1 " must be sent in order to switch in " EXTERN / REMOTE " mode. The command " B 0 " switches back to " INTERN " mode.

For the "IEE-488" interface, if the connection with the bus is interrupted, the power supply switches back to "INTERN" mode. For the RS232 interface, an interruption causes no automatic switching. The commands "B1" and "B0" may be sent over the IEEE-488 bus too. If the command "B1" was sent, a disconnection from the IEEE-488 bus will not cause automatic switching back to "INTERN".